

7850 PROFILE

7000 Series

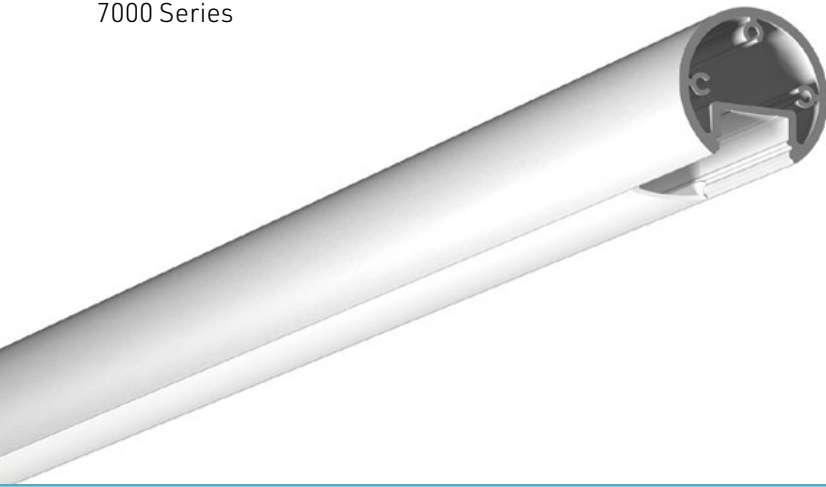

Cross-section dimensions:

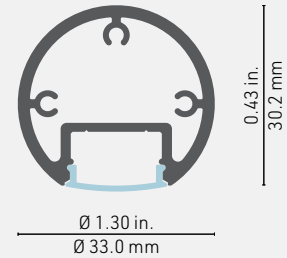

The 7850 is a **direct replacement of standard closet rods, and even curtain rods**. Whether you need to light your way through the morning wardrobe, or turn your sheer curtains into a privacy screen at night, this profile will do the job. This profile can even be used to replace your shower curtain rod when installed with IP68 graded LED engine and power supply suitable for wet locations.

FEATURES

- Standard diameter for wardrobe rods, compatible with a wide range of hardware on the market.
- Compatible with the 1000 Series lenses.
- Custom length by sections of 6 to 240 inches (6m).
- Application guide for 10mm (3/8-inch) LED engine or less.
- Made of ALCOA 6063-T5 aluminum alloy increasing heat dissipation.
- Designed to meet North American woodworking standards.

OPTIONS



LED ENGINE COMPATIBILITY



















IP22: Compatible with LED engines up to **14mm** wide.

IP68: Compatible with LED engines up to **10mm** wide.















LINEAR WEIGHT

0.442 lbs/ft, 0.658 kg/m (without lens)



PROFILE	LENSES	MOUNTING HARDWARE	SUPPORT	MOTION SENSORS*	LENGTH
 <p>7850 - Profile, Alu</p>	 <p>CL - Clear lens</p>  <p>SP - Spread lens</p>  <p>OX - Optiflex lens</p>  <p>OP - Opal lens</p>  <p>PR - Prime lens</p> <p> NO - No lens</p>	<p> BR1 - Heavy duty Closet Rod bracket kit</p> <p> BR3 - Screwless finish hangers</p> <p> EC0 - Standard endcaps, Alu.</p> <p> NO - No mounting hardware</p>	<p> BR2 - Ceiling support (should be ordererd at every 48")</p> <p> NO - No support</p>	<p> SEN1 - 30 sec. Embedded</p> <p> SEN2 - 30 sec. Outside extrusion</p> <p> SEN3 - 4 min. Embedded</p> <p> SEN4 - 4 min. Outside extrusion</p> <p> NO - No sensor</p>	<p>Custom length by sections of 6 to 240 inches (6m).</p>
7850					
PROFILE	LENS	MOUNTING HARDWARE	SUPPORT QTY (every 48")	MOTION SENSOR	LENGTH

***NOTES**
All motion sensors: Max 36W/12V or 72W/24V

COLOR TEMPERATURE	LUMEN PACKAGE*	LEAD IN/OUT	USAGE	POWER SUPPLY/CONTROL	*NOTES
<p> 24 - 2400K</p> <p> 27 - 2700K</p> <p> 30 - 3000K</p> <p> 35 - 3500K</p> <p> 42 - 4200K</p> <p> 53 - 5300K (LHP only)</p> <p> 62 - 6200K (LP only)</p> <p> WD1 - WarmDim 14W</p> <p> WD2 - WarmDim 17W</p> <p> TW1 - Tunable White 11W</p> <p> TW2 - Tunable White 19W</p> <p> RGB1 - RGB 14W</p> <p> RGB2 - RGB 19W</p> <p> RGBW1 - 3000K</p> <p> RGBW2 - 3000K 4in1</p>	<p>LP0 - 128 LM / 1.5W FT / 90+CRI</p> <p>LP1 - 160 LM / 1.5W FT / 90+CRI</p> <p>LP2 - 255 LM / 3.0W FT / 90+CRI</p> <p>LP3 - 308 LM / 4.5W FT / 90+CRI</p> <p>LP4 - 400 LM / 5.8W FT / 90+CRI</p> <p>LHP - 700 LM / 7.0W FT / 95+CRI</p> <p>Note: Not applicable for Warmdim Tunable White & RGB color temperatures</p>	<p>HW3 - Hardwire 3 FT</p> <p>HW6 - Hardwire 6 FT</p> <p>HW9 - Hardwire 9 FT</p> <p>HWX - Hardwire custom FT</p> <p>DC3 - DC plug 3 FT</p> <p>DC6 - DC plug 6 FT</p> <p>DC9 - DC plug 9 FT</p> <p>DCX - DC plug custom FT</p> <p>NO - No lead</p>	<p>I - IP22 indoor dry location</p> <p>O - IP68 wet/damp location</p>	<p>A - Non-dimming</p> <p>B - ELV dimming 120V AC</p> <p>C - ELV dimming 120/277 VAC**</p> <p>D - 0/10V dimming 120/277 VAC</p> <p>E - Non-dimming DC plug in</p> <p>F - DMX</p> <p>G - Lutron - HI-LUME PREMIER 0,1% Eco System 24V/96W</p> <p>I - Casambi CBU-A2D-0/10V-DALI-Bluetooth 100/277 VAC</p> <p>J - Casambi CBU-PWM4-4CH-Bluetooth 100/277 VAC</p> <p>K - Casambi CBU-TED-CV-Trail edge dim-Bluetooth 120 VAC</p> <p>NO - No driver</p>	<p>*The light output is provided in lumens per foot, for a CCT of 4200K and a clear lens. Please refer to the optics page for CCT and translucency conversion factors.</p> <p>** Only available in 96W - 24V Driver</p> <div style="border: 1px solid black; padding: 2px; display: inline-block;"> <p>TITLE 24 COMPONENTS</p> </div>
COLOR TEMPERATURE CCT	LUMEN PACKAGE	LEAD IN LEAD OUT	USAGE	POWER SUPPLY/CONTROL	

Serie 7850 (7850) LM22850-20

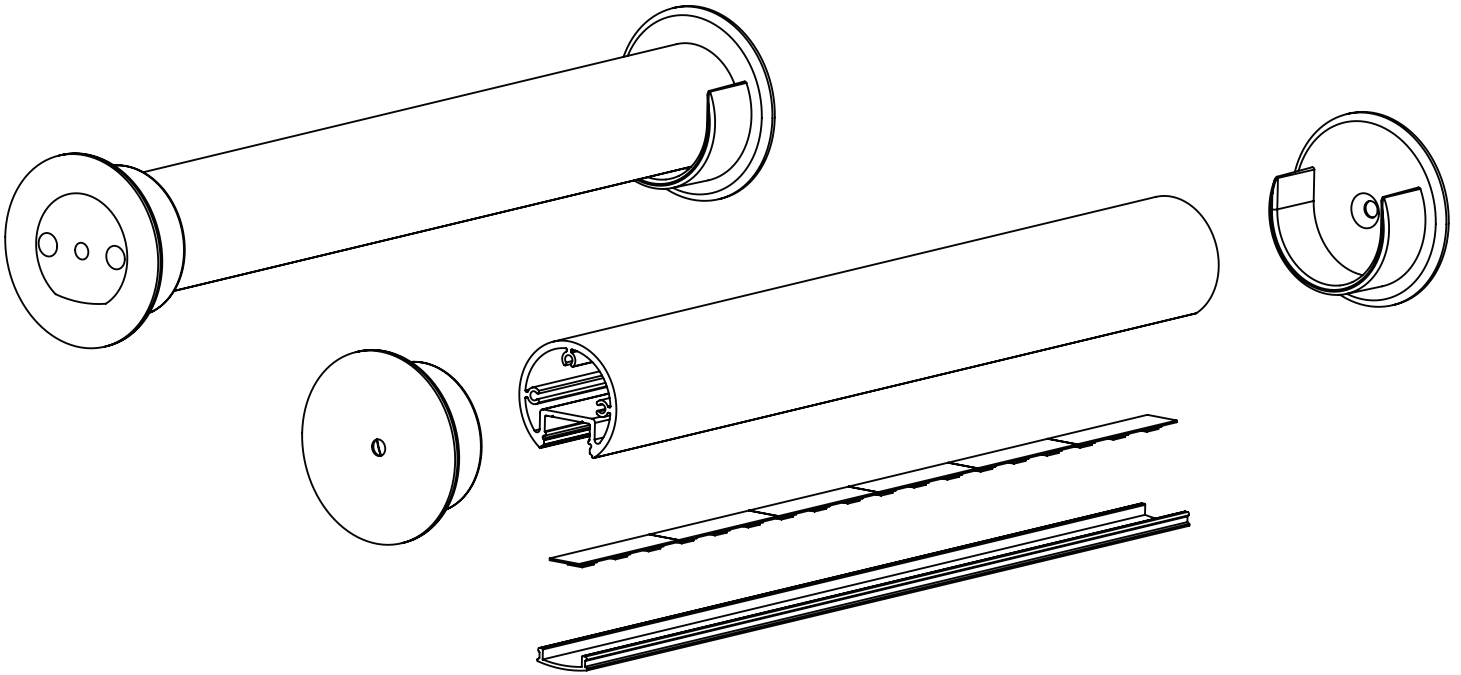

ASSEMBLY DIMENSION / DIMENSION D'ASSEMBLAGE

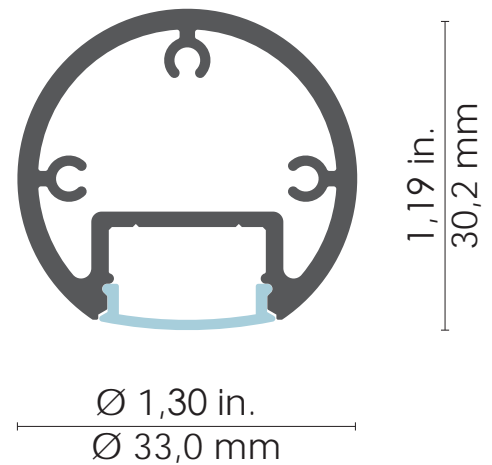
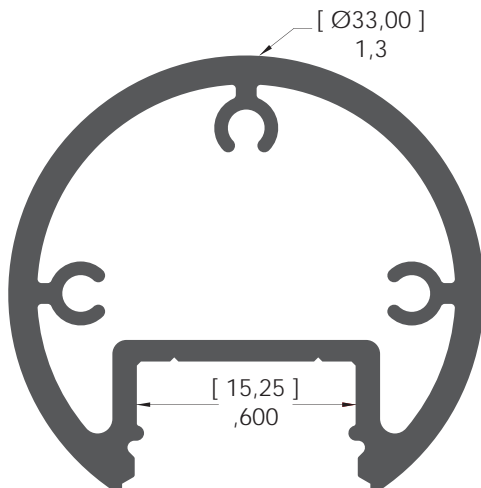

[mm]
inches/pouces

NOTES

